

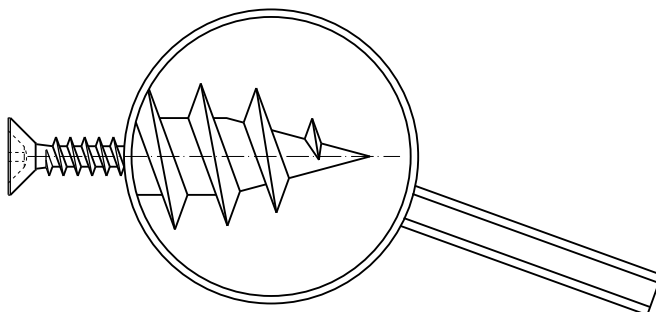



























Wkręty typu UNIX
Винты типа UNIX
 Chipboard screws, UNIX type

031



031.01		031.05	
031.02		031.06	
031.03		031.07	
031.04		031.08	

- i
- 011 
- 012 
- 013 
- 014 
- 015 
- 021 
- 022 
- 023 
- 024 
- 031 
- 032 
- 033 
- 034 
- 035 
- 036 
- 037 
- 038 
- 048 
- 049 

- 011
- 012
- 013
- 014
- 015
- 021
- 022
- 023
- 024
- 031
- 032
- 033
- 034
- 035
- 036
- 037
- 038
- 048
- 049

ZN: 180A	031.01
	UP

Wkręt UNIX z łbem z podkładką
Винт UNIX с головкой с буртиком
Pozidrive button head chipboard screw,
UNIX type

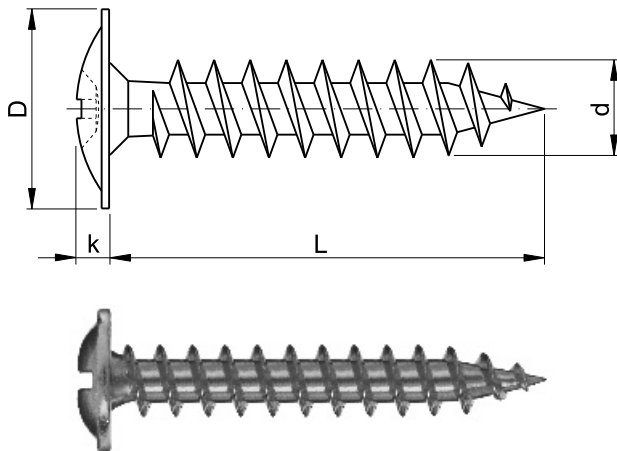

d	2,5	3,0	3,5	4,0	4,5	5,0	6,0
L							
10	●	●	●	●			
13	●	●	●	●			
16	●	●	●	●	●	●	●
20	●	●	●	●	●	●	●
25		●	●	●	●	●	●
30		●	●	●	●	●	●
35			●	●	●	●	●
40			●	●	●	●	●
45						●	●
50							●
60							●
70							●
75							●
80							●

d	D	k	T	PZ PH	I	
2,5	6,0	1,4	8	1	1,5	0,8
3,0	7,0	1,6	10	1	2	1,4
3,5	8,0	1,8	15	2	2,5	2,0
4,0	9,0	2,0	20	2	2,5	3,0
4,5	10	2,3	20	2	3	4,3
5,0	12	2,6	25	2	3	6,1
6,0	14	3,4	30	3	4	11,0

Wkręt UNIX z łbem z podkładką na części gwintowany

Винт UNIX с головкой с буртиком и неполной резьбой

Pozidrive button head chipboard screw, UNIX type, partly threaded

ZN: 180B	031.02
	UP

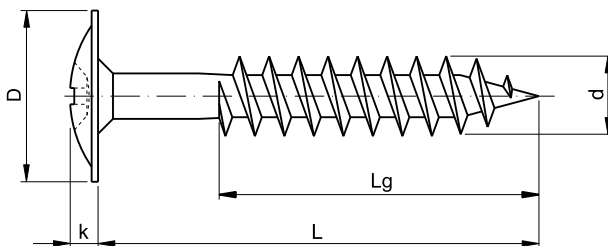

d	2,5	3,0	3,5	4,0	4,5	5,0	6,0	
Lg	min	16	16	18	20	20	20	40
	max	16	30	35	55	55	70	95
L								
25	●							
30	●							
35	●							
40	●	●	●	●	●			
45		●	●	●	●	●		
50		●	●	●	●	●	●	
60			●	●	●	●	●	
70			●	●	●	●	●	
80				●	●	●	●	
90						●	●	
100						●	●	
110						●	●	
120						●	●	
150							●	
160							●	
180							●	
200							●	
220							●	
240							●	

d	D	k	T	PZ PH	I	PH
2,5	6,0	1,4	8	1	1,5	0,8
3,0	7,0	1,6	10	1	2,0	1,4
3,5	8,0	1,8	15	2	2,5	2,0
4,0	9,0	2,0	20	2	2,5	3,0
4,5	10	2,3	20	2	3,0	4,3
5,0	12	2,6	25	2	3,0	6,1
6,0	14	3,4	30	3	4,0	11,0

- 011
- 012
- 013
- 014
- 015
- 021
- 022
- 023
- 024
- 031
- 032
- 033
- 034
- 035
- 036
- 037
- 038
- 048
- 049

- 011
- 012
- 013
- 014
- 015
- 021
- 022
- 023
- 024
- 031
- 032
- 033
- 034
- 035
- 036
- 037
- 038
- 048
- 049

ZN: 100A	031.03
	US

Wkręt UNIX z łbem stożkowym
Винт UNIX с потайной головкой
 Pozidrive flat head chipboard screw,
 UNIX type

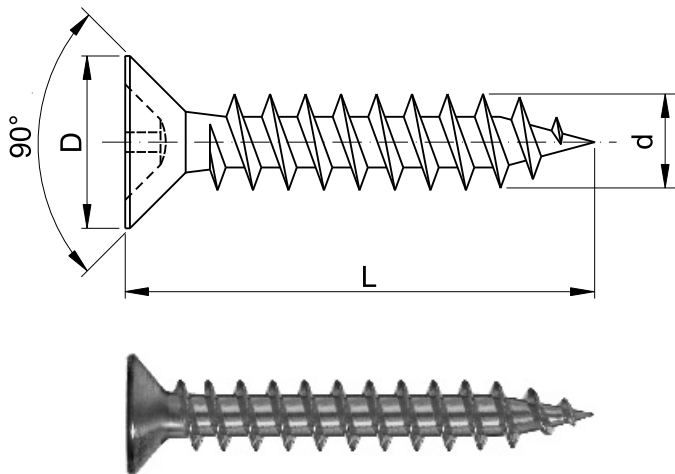

d	2,5	3,0	3,5	4,0	4,5	5,0	6,0
L							
10	●	●	●	●			
13	●	●	●	●	●		
16	●	●	●	●	●	●	
20	●	●	●	●	●	●	●
25		●	●	●	●	●	●
30		●	●	●	●	●	●
35		●	●	●	●	●	●
40			●	●	●	●	●
45			●	●	●	●	●
50				●	●	●	●
60					●	●	●
70							●
75							●
80							●

d	D	T	PZ PH	I	Icon
2,5	4,8	8	1	1,5	0,8
3,0	6,0	10	1	2,0	1,4
3,5	7,0	15	2	2,5	2,0
4,0	8,0	20	2	2,5	3,0
4,5	9,0	20	2	3,0	4,3
5,0	10,0	25	2	3,0	6,1
6,0	12,0	30	3	4,0	11,0

Wkręt UNIX z łbem stożkowym na części gwintowany

Винт UNIX с потайной головкой и неполной резьбой

Pozidrive flat head chipboard screw, UNIX type, partly threaded

ZN: 100B	031.04
	US

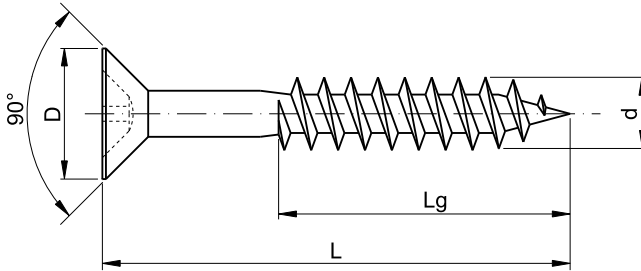

d	2,5	3,0	3,5	4,0	4,5	5,0	6,0	
Lg	min	16	16	18	20	20	20	40
	max	16	30	35	55	55	70	95
L								
25	●							
30	●							
35	●							
40	●	●	●	●	●	●		
45		●	●	●	●	●		
50			●	●	●	●	●	
60			●	●	●	●	●	
70			●	●	●	●	●	
80				●	●	●	●	
90					●	●	●	
100						●	●	
110						●	●	
120							●	
150								●
160								●
180								●
200								●
220								●
240								●

d	D	T	PZ PH	I	PH
2,5	4,8	8	1	1,5	0,8
3,0	6,0	10	1	2,0	1,4
3,5	7,0	15	2	2,5	2,0
4,0	8,0	20	2	2,5	3,0
4,5	9,0	20	2	3,0	4,3
5,0	10,0	25	2	3,0	6,1
6,0	12,0	30	3	4,0	11,0

- i
- 011
- 012
- 013
- 014
- 015
- 021
- 022
- 023
- 024
- 031
- 032
- 033
- 034
- 035
- 036
- 037
- 038
- 048
- 049

- 011
- 012
- 013
- 014
- 015
- 021
- 022
- 023
- 024
- 031
- 032
- 033
- 034
- 035
- 036
- 037
- 038
- 048
- 049

ZN: 120A	031.05
	UT

Wkręt UNIX z łbem stożkowym soczewkowym

Винт UNIX с полупотайной головкой

Pozidrive oval head chipboard screw, UNIX type

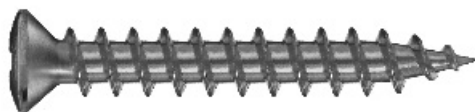
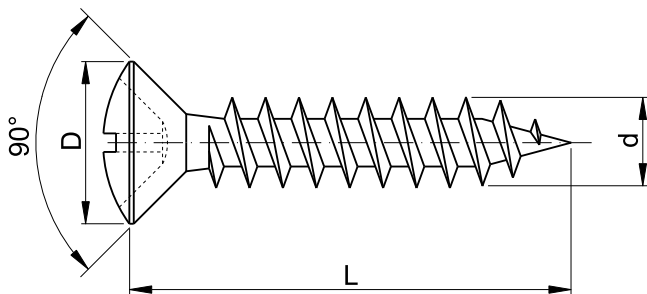

d	2,5	3,0	3,5	4,0	4,5	5,0	6,0
L							
10	●	●	●	●			
13	●	●	●	●	●		
16	●	●	●	●	●	●	
20	●	●	●	●	●	●	●
25		●	●	●	●	●	●
30		●	●	●	●	●	●
35		●	●	●	●	●	●
40			●	●	●	●	●
45			●	●	●	●	●
50				●	●	●	●
60					●	●	●
70							●
75							●
80							●

d	D	T	PZ PH	I	
2,5	4,8	8	1	1,5	0,8
3,0	6,0	10	1	2,0	1,4
3,5	7,0	15	2	2,5	2,0
4,0	8,0	20	2	2,5	3,0
4,5	9,0	20	2	3,0	4,3
5,0	10,0	25	2	3,0	6,1
6,0	12,0	30	3	4,0	11,0

Wkręt UNIX z łbem stożkowym soczewkowym na części gwintowany

Винт UNIX с полупотайной головкой и неполной резьбой

Pozidrive oval head chipboard screw, UNIX type, partly threaded

ZN: 120B	031.06
	UT

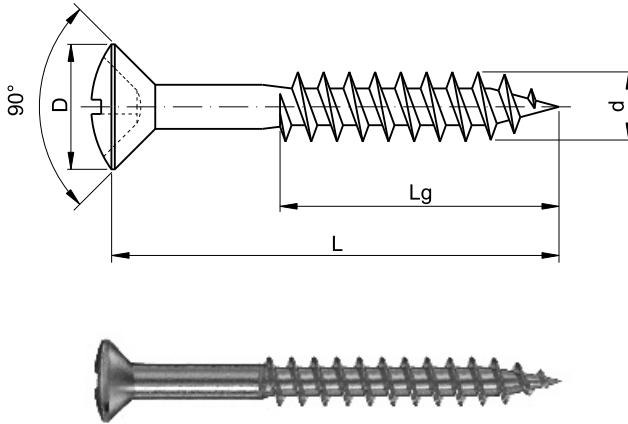

d	2,5	3,0	3,5	4,0	4,5	5,0	6,0	
Lg	min	16	16	18	20	20	20	40
	max	16	30	35	55	55	70	95
L								
25	●							
30	●							
35	●							
40	●	●		●	●	●		
45		●	●	●	●	●		
50			●	●	●	●	●	
60			●	●	●	●	●	
70			●	●	●	●	●	
80				●	●	●	●	
90						●	●	
100						●	●	
110						●	●	
120						●	●	
150							●	
160							●	
180							●	
200							●	
220							●	
240							●	

d	D	T	PH	I	PH
2,5	4,8	8	1	1,5	0,8
3,0	6,0	10	1	2,0	1,4
3,5	7,0	15	2	2,5	2,0
4,0	8,0	20	2	2,5	3,0
4,5	9,0	20	2	3,0	4,3
5,0	10,0	25	2	3,0	6,1
6,0	12,0	30	3	4,0	11,0

- i
- 011
- 012
- 013
- 014
- 015
- 021
- 022
- 023
- 024
- 031
- 032**
- 033
- 034
- 035
- 036
- 037
- 038
- 048
- 049

- 011
- 012
- 013
- 014
- 015
- 021
- 022
- 023
- 024
- 031
- 032
- 033
- 034
- 035
- 036
- 037
- 038
- 048
- 049

ZN: 140A	031.07
	UW

Wkręt UNIX z łbem walcowym
Винт UNIX с полукруглой головкой
Pozidrive pan head chipboard screw, UNIX type

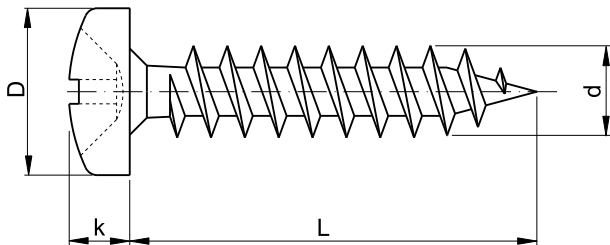

d	2,5	3,0	3,5	4,0	4,5	5,0	6,0
L							
10	●	●	●	●			
13	●	●	●	●			
16	●	●	●	●	●	●	●
20	●	●	●	●	●	●	●
25		●	●	●	●	●	●
30		●	●	●	●	●	●
35			●	●	●	●	●
40			●	●	●	●	●
45						●	●
50							●
60							●
70							●
75							●
80							●

d	D	k	T	PZ PH	I	
2,5	4,8	1,9	10	1	1,5	0,8
3,0	5,9	2,2	10	1	2,0	1,4
3,5	6,9	2,6	15	2	2,5	2,0
4,0	7,9	2,8	20	2	2,5	3,0
4,5	8,9	3,2	20	2	3,0	4,3
5,0	9,6	3,5	25	2	3,0	6,1
6,0	11,6	3,9	30	3	4,0	11,0

Wkręt UNIX z łbem walcowym na części gwintowany

Винт UNIX с полукруглой головкой и неполной резьбой

Pozidrive pan head chipboard screw, UNIX type, partly threaded

ZN: 140B	031.08
	UW

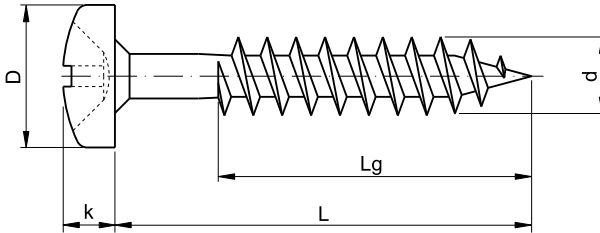

d	2,5	3,0	3,5	4,0	4,5	5,0	6,0	
Lg	min	16	16	18	20	20	20	40
	max	16	30	35	55	55	70	95
L								
25	●							
30	●							
35	●							
40	●	●	●	●	●			
45		●	●	●	●	●		
50		●	●	●	●	●	●	
60			●	●	●	●	●	
70			●	●	●	●	●	
80				●	●	●	●	
90						●	●	
100						●	●	
110						●	●	
120						●	●	
150							●	
160							●	
180							●	
200							●	
220							●	
240							●	

d	D	k	T	PZ PH	I	PH
2,5	4,8	1,9	10	1	1,5	0,8
3,0	5,9	2,2	10	1	2,0	1,4
3,5	6,9	2,6	15	2	2,5	2,0
4,0	7,9	2,8	20	2	2,5	3,0
4,5	8,9	3,2	20	2	3,0	4,3
5,0	9,6	3,5	25	2	3,0	6,1
6,0	11,6	3,9	30	3	4,0	11,0

- i
- 011
- 012
- 013
- 014
- 015
- 021
- 022
- 023
- 024
- 031
- 032
- 033
- 034
- 035
- 036
- 037
- 038
- 048
- 049

i

011



012



013



014



015



021



022



023



024



031



032



033



034



035



036



037



038



048



049

