

**Wkręty do tworzyw sztucznych**  
**Винты для пластмассы**  
 Screws for plastics

**033**

**Wkręty do tworzyw sztucznych z gwintem HILO**  
**Винты для пластмассы с резьбой HILO**  
 Screws for plastics with HILO thread

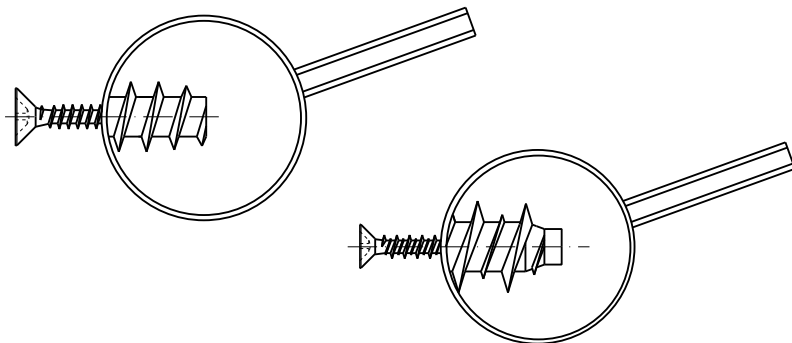

033.01		033.05	
033.02		033.06	
033.03		033.07	
033.04		033.08	
		033.09	

- i
- 011
- 012
- 013
- 014
- 015
- 021
- 022
- 023
- 024
- 031
- 032
- 033
- 034
- 035
- 036
- 037
- 038
- 048
- 049

- 011
- 012
- 013
- 014
- 015
- 021
- 022
- 023
- 024
- 031
- 032
- 033
- 034
- 035
- 036
- 037
- 038
- 048
- 049

ZN: 581	033.01
	TP

**Wkręt do tworzyw sztucznych z łbem z podkładką z wprowadzeniem**

**Винт для пластмассы с головкой с буртиком и вводом**

**Button head screw for plastics with pilot**

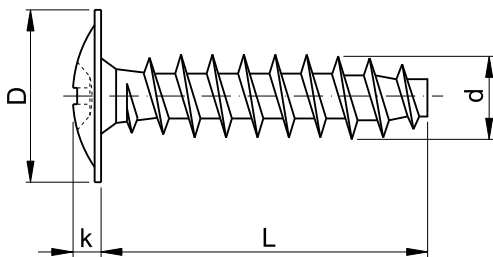

d	3,1	3,6	4,1	5,1	6,1
L					
10	●	●			
13	●	●			
16	●	●	●	●	●
20	●	●	●	●	●
25	●	●	●	●	●
30	●	●	●	●	●
35		●	●	●	●
40		●		●	●
45				●	●
50					●
60					●
70					●
75					●
80					●

d	D	k	T	PZ PH	I	Icon
3,1	7,0	1,6	10	1	2,0	1,4
3,6	8,0	1,8	15	2	2,5	2,0
4,1	9,0	2,0	20	2	2,5	3,0
5,1	12,0	2,6	25	2	3,0	6,1
6,1	14,0	3,4	30	3	4,0	11,0

# Wkręt do tworzyw sztucznych z gwintem HILO z fblem z podkładką z wprowadzeniem

Винт для пластмассы с резьбой HILO с головкой с буртиком и вводом

Button head screw for plastics with pilot with "HILO" thread

ZN: 581H	<b>033.02</b>
	TP

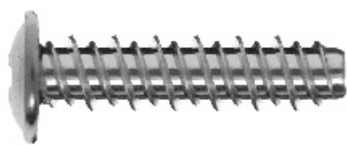
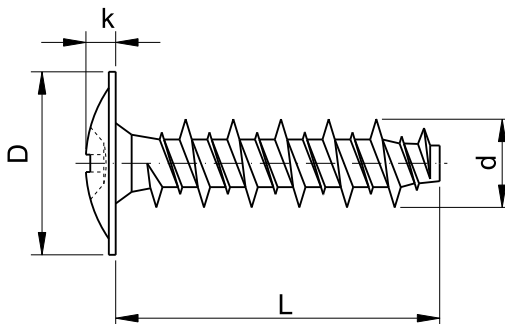

d	3,1	3,6	4,1	5,1	6,1
L					
10	●	●			
13	●	●			
16	●	●	●	●	●
20	●	●	●	●	●
25	●	●	●	●	●
30	●	●	●	●	●
35		●	●	●	●
40		●		●	●
45				●	●
50					●
60					●
70					●
75					●
80					●

d	D	k	T	PZ PH	I	
3,1	7,0	1,6	10	1	2,0	1,4
3,6	8,0	1,8	15	2	2,5	2,0
4,1	9,0	2,0	20	2	2,5	3,0
5,1	12,0	2,6	25	2	3,0	6,1
6,1	14,0	3,4	30	3	4,0	11,0

- 011
- 012
- 013
- 014
- 015
- 021
- 022
- 023
- 024
- 031
- 032
- 033
- 034
- 035
- 036
- 037
- 038
- 048
- 049

- 011
- 012
- 013
- 014
- 015
- 021
- 022
- 023
- 024
- 031
- 032
- 033
- 034
- 035
- 036
- 037
- 038
- 048
- 049

ZN: 501	033.03
	TS

**Wkręt do tworzyw sztucznych z łbem stożkowym z wprowadzeniem**

**Винт для пластмассы с потайной головкой с вводом**

**Flat head screw for plastics with pilot**

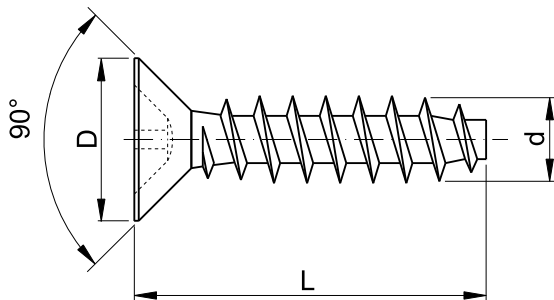

d	3,1	3,6	4,1	5,1	6,1
L					
10	●	●			
13	●	●			
16	●	●	●	●	●
20	●	●	●	●	●
25	●	●	●	●	●
30	●	●	●	●	●
35		●	●	●	●
40		●	●	●	●
45			●	●	●
50					●
60					●
70					●
75					●
80					●

d	D	T	PZ PH	I	
3,1	6,0	10	1	2,0	1,4
3,6	7,0	15	2	2,5	2,0
4,1	8,0	20	2	2,5	3,0
5,1	10,0	25	2	3,0	6,1
6,1	12,0	30	3	4,0	11,0

**Wkręt do tworzyw sztucznych z gwintem HILO z łbem z stożkowym z wprowadzeniem**

**Винт для пластмассы с резьбой HILO с потайной головкой с вводом**

**Flat head screw for plastics with pilot with "HILO" thread**

ZN: 501H	<b>033.04</b>
	TS

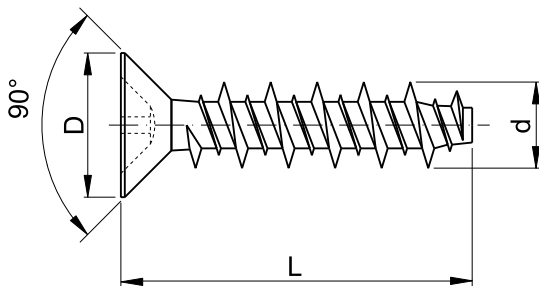

d	3,1	3,6	4,1	5,1	6,1
L					
10	●	●			
13	●	●			
16	●	●	●	●	●
20	●	●	●	●	●
25	●	●	●	●	●
30	●	●	●	●	●
35		●	●	●	●
40		●		●	●
45				●	●
50					●
60					●
70					●
75					●
80					●

d	D	T	PZ PH	I	TS
3,1	6,0	10	1	2,0	1,4
3,6	7,0	15	2	2,5	2,0
4,1	8,0	20	2	2,5	3,0
5,1	10,0	25	2	3,0	6,1
6,1	12,0	30	3	4,0	11,0

- i
- 011
- 012
- 013
- 014
- 015
- 021
- 022
- 023
- 024
- 031
- 032
- 033
- 034
- 035
- 036
- 037
- 038
- 048
- 049

- 011
- 012
- 013
- 014
- 015
- 021
- 022
- 023
- 024
- 031
- 032
- 033
- 034
- 035
- 036
- 037
- 038
- 048
- 049

ZN: 521	<b>033.05</b>
	<b>TT</b>

**Wkręt do tworzyw sztucznych z łbem stożkowym soczewkowym z wprowadzeniem**

**Винт для пластмассы с полупотайной головкой с вводом**

**Oval head screw for plastics with pilot**

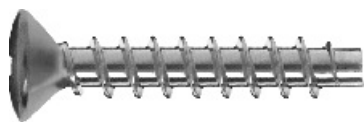
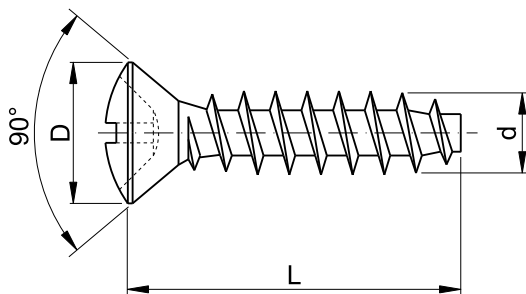

d	3,1	3,6	4,1	5,1	6,1
L					
10	●	●			
13	●	●			
16	●	●	●	●	●
20	●	●	●	●	●
25	●	●	●	●	●
30	●	●	●	●	●
35		●	●	●	●
40		●	●	●	●
45				●	●
50					●
60					●
70					●
75					●
80					●

d	D	T	PZ PH	I	
3,1	6,0	10	1	2,0	1,4
3,6	7,0	15	2	2,5	2,0
4,1	8,0	20	2	2,5	3,0
5,1	10,0	25	2	3,0	6,1
6,1	12,0	30	3	4,0	11,0

**Wkręt do tworzyw sztucznych z gwintem HILO z łbem z stożkowym soczewkowym z wprowadzeniem**

**Винт для пластмассы с резьбой HILO с полупотайной головкой с вводом**

**Oval head screw for plastics with pilot with "HILO" thread**

ZN: 521H	<b>033.06</b>
	TT

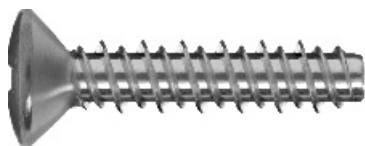
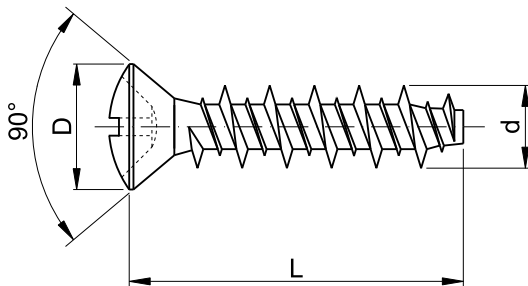

d	3,1	3,6	4,1	5,1	6,1
L					
10	●	●			
13	●	●			
16	●	●	●	●	●
20	●	●	●	●	●
25	●	●	●	●	●
30	●	●	●	●	●
35		●	●	●	●
40				●	●
45				●	●
50					●
60					●
70					●
75					●
80					●

d	D	T	PZ PH	I	
3,1	6,0	10	1	2,0	1,4
3,6	7,0	15	2	2,5	2,0
4,1	8,0	20	2	2,5	3,0
5,1	10,0	25	2	3,0	6,1
6,1	12,0	30	3	4,0	11,0

- i
- 011
- 012
- 013
- 014
- 015
- 021
- 022
- 023
- 024
- 031
- 032
- 033
- 034
- 035
- 036
- 037
- 038
- 048
- 049

- 011
- 012
- 013
- 014
- 015
- 021
- 022
- 023
- 024
- 031
- 032
- 033
- 034
- 035
- 036
- 037
- 038
- 048
- 049

ZN: 541	033.07
	TW

## Wkręt do tworzyw sztucznych z łbem walcowym z wprowadzeniem

Винт для пластмассы с полукруглой головкой с вводом

Pan head screw for plastics with pilot

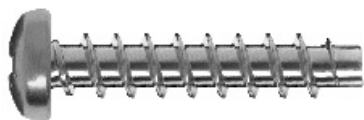
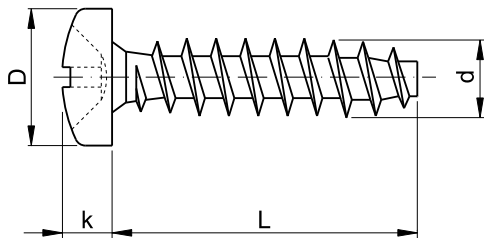

d	3,1	3,6	4,1	5,1	6,1
L					
10	●	●			
13	●	●			
16	●	●	●	●	●
20	●	●	●	●	●
25	●	●	●	●	●
30	●	●	●	●	●
35		●	●	●	●
40		●		●	●
45				●	●
50					●
60					●
70					●
75					●
80					●

d	D	k	T	PZ PH	I	
3,1	5,9	2,2	10	1	2,0	1,4
3,6	6,9	2,6	15	2	2,5	2,0
4,1	7,9	2,8	20	2	2,5	3,0
5,1	9,6	3,5	25	2	3,0	6,1
6,1	11,6	3,9	30	3	4,0	11,0

# Wkręt do tworzyw sztucznych z gwintem HILO z łbem z walcowym z wprowadzeniem

Винт для пластмассы с резьбой HILO с полукруглой головкой с вводом

Pan head screw for plastics with pilot with "HILO" thread

ZN: 541H	<b>033.08</b>
	TW

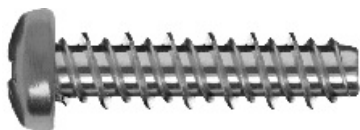
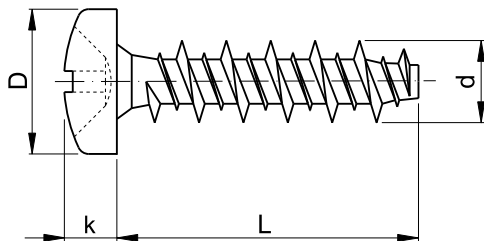

d	3,1	3,6	4,1	5,1	6,1
L					
10	●	●			
13	●	●			
16	●	●	●	●	●
20	●	●	●	●	●
25	●	●	●	●	●
30	●	●	●	●	●
35		●	●	●	●
40		●		●	●
45				●	●
50					●
60					●
70					●
75					●
80					●

d	D	k	T	PZ PH	I	PH
3,1	5,9	2,2	10	1	2,0	1,4
3,6	6,9	2,6	15	2	2,5	2,0
4,1	7,9	2,8	20	2	2,5	3,0
5,1	9,6	3,5	25	2	3,0	6,1
6,1	11,6	3,9	30	3	4,0	11,0

- 011
- 012
- 013
- 014
- 015
- 021
- 022
- 023
- 024
- 031
- 032
- 033
- 034
- 035
- 036
- 037
- 038
- 048
- 049

- i
- 011
- 012
- 013
- 014
- 015
- 021
- 022
- 023
- 024
- 031
- 032
- 033
- 034
- 035
- 036
- 037
- 038
- 048
- 049

ZN: 500P	<b>033.09</b>
	OS



## Wkręt okuciowy do stalorki PCV

Винт для приборов столярки PCV

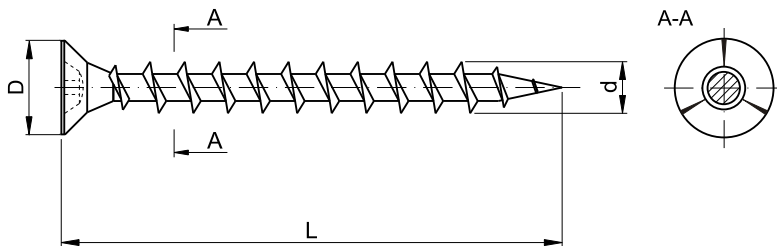
Flat head window screw



d	4,2
L	16
	25
	30
	35
	40
	45

d	D	 PH	
4,2	7,4	2	3,5